

YUEQING HONGYI ELECTRONICS CO., LTD  
乐清市宏一电子有限公司

SPECIFICATION FOR APPROVAL  
承认书

CUSTOMER 客户名称	
DESCRIPRION 产品名称	952802 系列连接器
ITEM NO 编 号	HY-C25405 (C23)
DATE 日 期	2024-08-02

CUSTOMER ACKNOWLEDGEMENT SEAL

客户承认印签

(APPROVAL) 核准	(ENGINEERING) 工程	(PURCHASE) 采购	(QUALITY) 品质
承认结果: <input type="checkbox"/> 通过 <input type="checkbox"/> 不通过 <input type="checkbox"/> 重新送样			

IS09001

IS014001

IS045001

IATF16949 体系认证

ADD: No. 30, Wenjing Road, Houyu village, Shifan street, Yueqing City, Zhejiang Province

地此: 浙江省乐清市石帆街道后屿文景路 30 号

TEL:0577-62380521

FAX: 0577-62381979 P.C:325608

http: //www.zhehongyi.com

E-MAIL:yaohongxiao88@126.com



# 产 品 承 认 书 目 录

1、封面	1-1
2、修订履历	2-2
3、目录	3-3
4、技术规范	4-7
5、产品图纸	8-9

# PRODUCT SPECIFICATION

## 产品规范

### 1、Scope

#### 适用范围

This specification includes the following specifications, including the specification of 2.54mm pitch 952802 series connector

本规范包括下列此种规格包括 2.54mm Pitch 952802 系列连接器规格说明

### 2、Appearance and Dimension

#### 外观及尺寸

2.1 Appearance: Product surface without defect, dirt, crack, and mechanical damage, Contact without rust, plating not oxidized and not peeled.

产品表面不应有对制品有害的缺陷、污垢、裂痕及机械损伤；接触件无锈蚀、镀层氧化脱落等现象

2.2 Dimension: According to drawings

外形尺寸：依照附图

### 3、Disposal of Material and surface

#### 材料与表面处理

Specification 规格内容	Material 材质	Finish 表面处理	Environmental protection grade 环保等级
Terminal 端子	Phosphor bronze 磷铜 厚 0.20mm	Tin Plating: 2.5-5 $\mu$ m 镀锡: 2.5-5 $\mu$ m	RoHS2.0
Housing 胶壳	PBT UL94V-0	Color: Black 颜色: 黑色	

### 4、Ratings and applicable wires

#### 额定等级

Item 项目	Standard 规格
Rated Voltage 额定电压	50V AC/DC
Rated Current 额定电流	7.5A AC/DC
Ambient temperature Range 使用温度范围	-40°C - +120°C
Applicable wire insulation 适用线径	AWG24#-28#

## 5、Electrical Performance

### 电气性能

N0. 序号	Ltem 项目	Test mode 试验方法	Requirement 技术要求
5.1	ContactResistance 接触电阻	Male female cooperation, open voltage less than 20mV, current 100mA detection connector at both ends  公母配合, 开放电压20mV 以下, 电流100mA 检测连接器连接器两端	Initial:20mΩ Max 初始: 20mΩ Max  After Test: 30mΩ Max 试验后: 30mΩ Max
5.2	withstandvoltage 耐电压	Mate connectors, apply 500V AC for 1 minute between adjacent terminal or ground  公母配合, 在相邻端子, 端子与地片之间, 使用500V 的交流电1 分钟, 检测连接器	No Breakdown and Flashover  外观无损伤, 无打火花
5.3	InsulationResistance 绝缘电阻	Mate connectors, apply 500V DC between adjacent terminal or ground  公母配合, 在相邻端子, 端子与地片之间, 使用500V 的直流电, 检测连接器	1000MΩ Min

## 6、机械性能

### Mechanical Performance

N0. 序号	Ltem 项目	Test mode 试验方法	Requirement 技术要求	
6.1	Terminal crimping wire strength 端子压接导线强度	Fix the crimped terminal, apply axial pull out force on the wire  固定铆线后的端子, 使电线与端子分离时所需的最小力	AWG#24 wire AWG#24 导线	30N Min
			AWG#26 wire AWG#26 导线	20N Min
			AWG#28 wire AWG#28 导线	13N Min
6.2	Terminal/ Housing Retention Force 端子保持力	Apply axial pull out force at the speed rate of 25.4±3mm/minute on the terminal assembled in the Housing  以每分 25.4±3mm 的速率, 将端子从 Housing 内轴向拔出	Per contact: 15N Min 单一接触点: 15N Min	

6.3	Insertion & withdraw Force 插拔力	Insert and withdraw Connectors at the speed rate of 25.4±3mm/minute 以每分钟 25.4±3mm 的速率插入和拔出	Insertion force: 50N Max 插入力: 50N Max  Withdrawal force: 60N Min 拔出力: 60N Min
-----	-----------------------------------	---	---

## 7、Endurance Characteristics:

### 环境性能

N0. 序号	Ltem 项目	Test mode 试验方法	Requirement 技术要求	
7.1	Repeated Insertion/ Withdrawal 重复插拔	When mated up to 10 cycles repeatedly by the rate of 10 cycles per minute 以每分钟不超过 10 次的速率,将公母插拔 10 次	Contact Resistance 接触电阻	30 mΩ Max
7.2	Temperature Rise 温升测试	Mating connectors shall be energized at rating current until thermal stability is achieved, and then measured the temperature rise 公母连接器配合后,加载额定电流直到温度上升到稳定 状态,然后再测量温升	Temperature Rise 温升测试	30℃ Max
7.3	Vibration test 振动测试	Amplitude: 1.5mm P-P Sweep time: 10~55~10 HZ in 1 minute Duration: 2 hours in each X.Y.Z axials  振幅: 1.5mm P-P 时间: 10~55~10 HZ in 1 minute 持续时间: 每轴向 2 小时	Appearance 外观	No damage 无异常
			Contact Resistance 接触电阻	30 mΩ Max
			Discontinuity 瞬断	1 micro-second Max.
7.4	Heat Resistance 耐热性	120±2℃,96 hours	Appearance 外观	No damage 无异常
			Contact Resistance 接触电阻	30 mΩ Max
7.5	Cold Resistance 耐寒性	-40±3℃,96 hours	Appearance 外观	No damage 无异常
			Contact Resistance 接触电阻	30 mΩ Max

7.6	Humidity 耐湿性	Temperature: 60±2°C Relative Humidity: 90~95% Duration: 96 hours  温度: 60±2°C 湿度: 90~95%(RH) 持续时间: 96 hours	Appearance 外观	No damage 无异常
			Contact Resistance 接触电阻	30 mΩ Max
			Withstand Voltage 耐电压	No Breakdown and Flashover 外观无损伤, 无打火花
			Insulation Resistance 绝缘电阻	1000MΩ Min
7.7	温度变化 Temperature Cycling	5 cycles of: a) -40°C 30 minutes b) +120°C 30 minutes  从-40°C持续30 分钟升至+120°C持续30 分钟, 循环5 次	Appearance 外观	No damage 无异常
			Contact Resistance 接触电阻	30 mΩ Max
7.8	Salt spray 盐雾	24±1 hours exposure to a salt spray from the 5±1% solution at 35±2°C  在温度35±2°C, 盐水浓度5±1%下, 盐水喷 雾24±1 小时	Appearance 外观	No damage 无异常
			Contact Resistance 接触电阻	30 mΩ Max

REV.	日期	ECN NO.	变更内容	制图
			DESCRIPTION	DRAWN

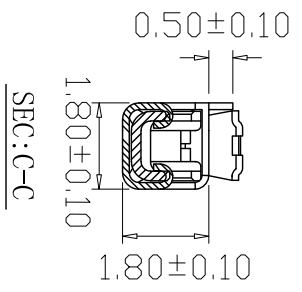
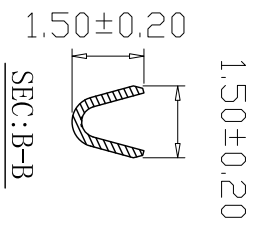
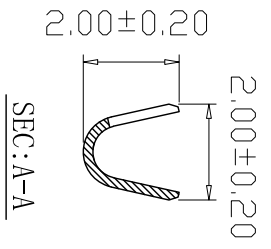
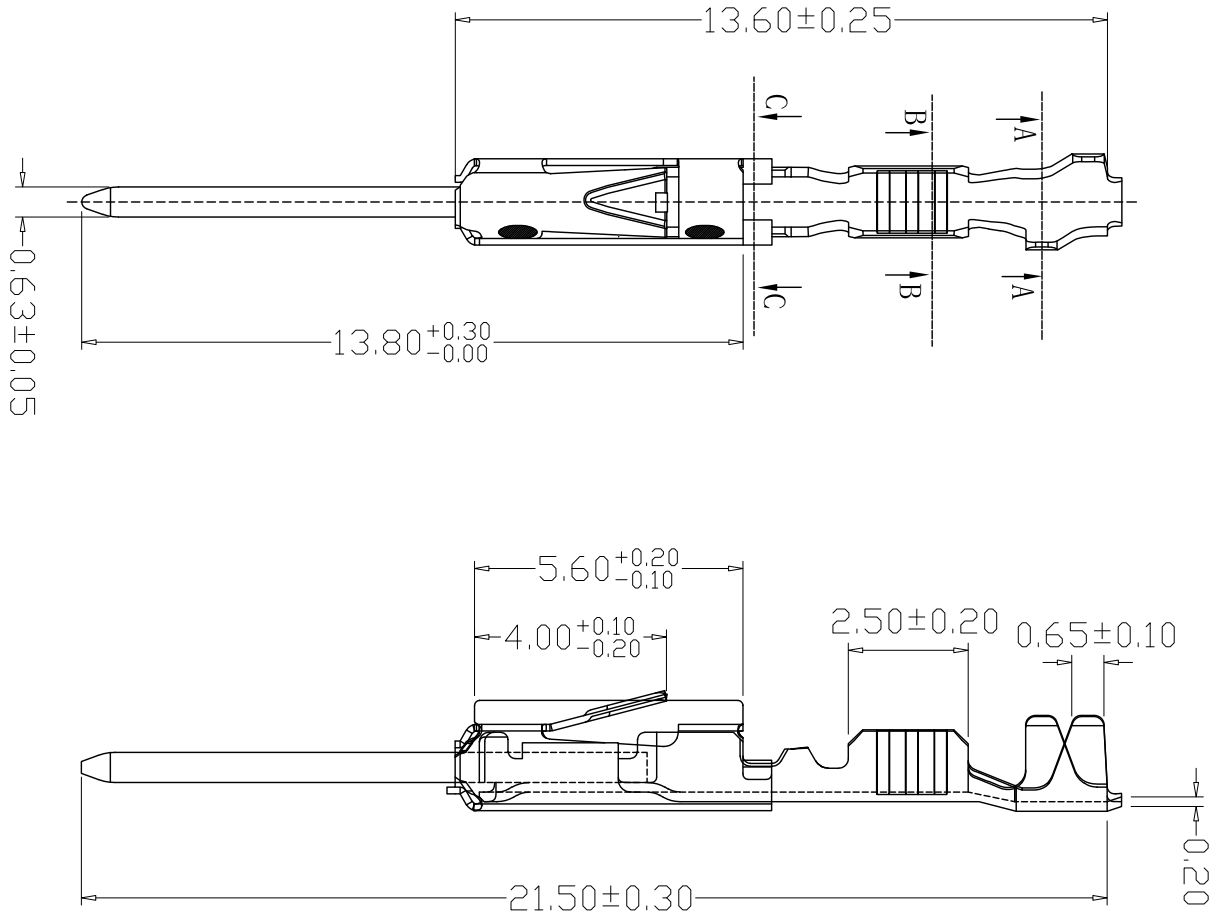

**SPECIFICATIONS**

- 1、Current Rating: 7.5A AC, DC
- 2、Voltage Rating: 50V AC, DC
- 3、Temperature Range: -40°C~+120°C
- 4、Contact Resistance: 20mΩ Max
- 5、Insulation Resistance: 1000MΩ Min
- 6、Withstanding Voltage: 500V AC/minute
- 7、Material: Phosphoric bronze Tin-plated
- 8、Applicable Wire Sizes: AWG#24~28#

GENERAL TOLERANCE		制图	料号	版本
X <sub>±0.25</sub>	X°±2°	Mapping	2024、08、01	REV.
X <sub>±0.25</sub>	X°±1°	审核	钱岳生	页次
X <sub>±0.15</sub>	X°±0.5°	核准	张名	1/1
XXX±0.10	XXX°±0.5°	Approved	2024、08、02	
		单位	mm	
		Units	SCALE	

**乐清市宏一电子有限公司**  
 Yueqing Hongyi Electronics Co., Ltd



版本 REV.	日期 DATE	ECN NO.	变更内容 DESCRIPTION	制图 DRAWN

SPECIFICATIONS

- 1、Current Rating: 7.5A AC, DC
- 2、Voltage Rating: 50V AC, DC
- 3、Temperature Range: -40°C~+120°C
- 4、Contact Resistance: 20mΩ Max
- 5、Insulation Resistance: 1000MΩ Min
- 6、Withstanding Voltage: 500V AC/minute
- 7、Material: PBT, UL94V-0

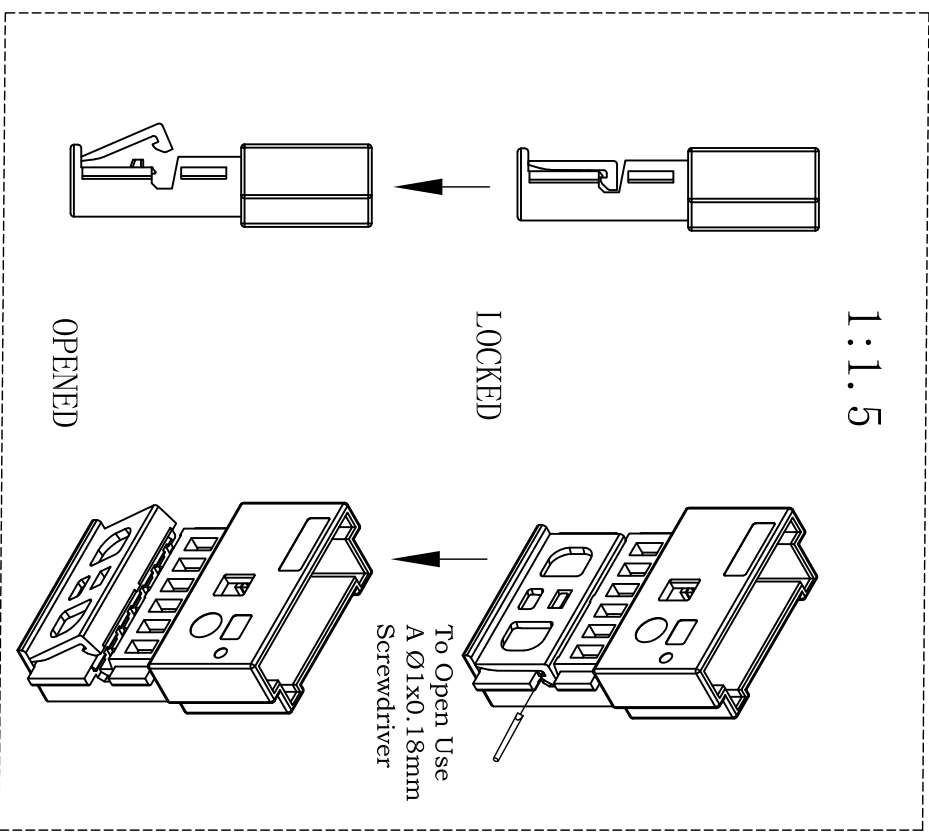
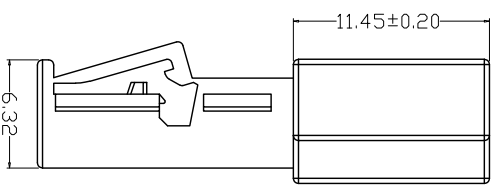
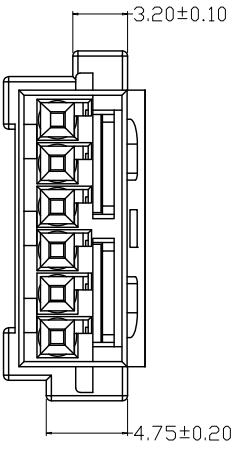
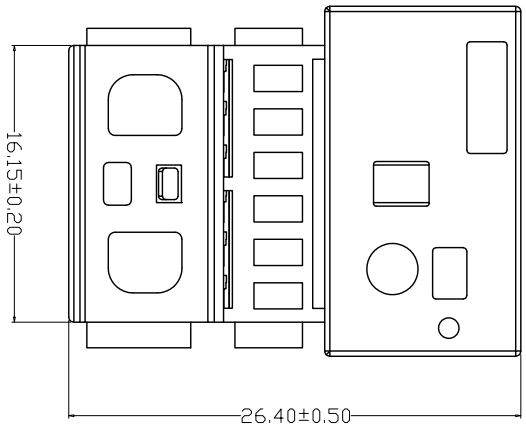
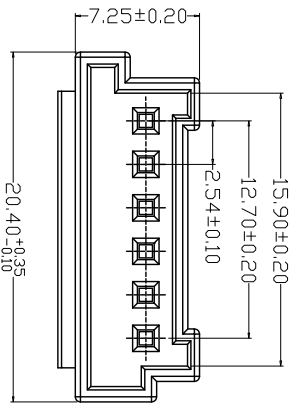

1:1.5

GENERAL TOLERANCE		制图 Mapping	姚勇	料号 PART NO.	C25405-6Y	版本 REV.	A
X $\pm$ 0.25	X $\pm$ 2°	审核 Audit	钱岳生	品名 TITLE	952802孔座	页次 SHEET	1/1
X $\pm$ 0.25	X $\pm$ 1°	核准 Approved	张名	客户料号 CSTM. NO.			
.XX $\pm$ 0.15	.XX $\pm$ 0.5°	单位 Units	2024. 08. 02	比例 SCALE		<b>乐清市宏一电子有限公司</b> YueDing HongYi Electronics Co., Ltd	
.XXX $\pm$ 0.10	.XXX $\pm$ 0.5°	mm					